

### 1.3 Kirchhoff's Laws and Nodal Analysis

The analysis of circuits is based on Kirchhoff's current law (KCL) and voltage law (KVL). The KCL states that the sum of all currents leaving any node at any time is zero. This is because charges ideally cannot accumulate at node. (In a real circuit, parasitic capacitances are present at all nodes. Their currents must be included to make this statement valid.) The KVL states that the sum of all branch voltages in a loop is zero. The Kirchhoff's laws are illustrated for a simple circuit in Fig. 1.7.

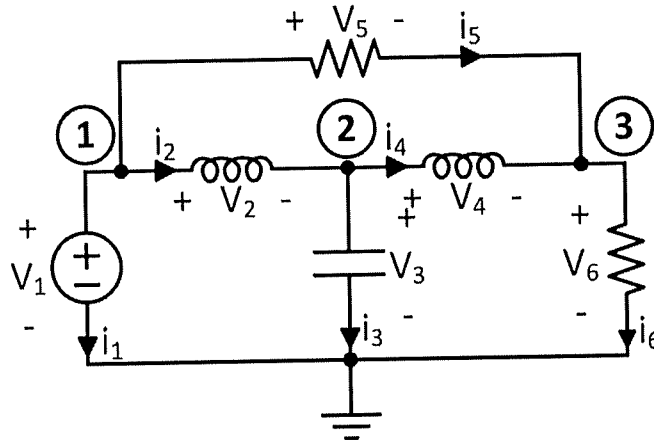

Figure 1.7: Circuit analysis example.

Denoting the current in branch  $k$  by  $i_k$ , the KCL leads to the relations

$$\begin{aligned} i_1 + i_2 + i_5 &= 0 \\ -i_2 + i_3 + i_4 &= 0 \\ -i_4 - i_5 + i_6 &= 0 \end{aligned} \tag{1.7}$$

Denoting the branch voltages by  $v_k$  and the node voltages by  $e_i$ , the KVL gives the equations

$$\begin{aligned} v_1 &= e_1 \\ v_2 &= e_1 - e_2 \\ v_3 &= e_2 \\ v_4 &= e_2 - e_3 \\ v_5 &= e_1 - e_3 \\ v_6 &= e_3 \end{aligned} \tag{1.8}$$

It is efficient at this point to introduce vector and matrix notations. We define the *incidence matrix*  $\mathbf{A}$ . Its element in row  $l$  and column  $j$  is

$$a_{ij} = \begin{cases} +1 & \text{if branch } j \text{ leaves node } i \\ -1 & \text{if branch } j \text{ enters node } i \\ 0 & \text{if branch } j \text{ is not incident at node } i \end{cases} \quad (1.9)$$

The branch currents can be collected into a column vector  $\mathbf{I} = [i_1, i_2, \dots, i_b]^T$ . Here,  $b$  is the number of branches in the circuit. Then, the KCLs can be written in the simple form

$$\mathbf{A} \cdot \mathbf{i} = \mathbf{0} \quad (1.10)$$

Here,  $\mathbf{0}$  is the column vector of zeros.

Similarly, collecting the branch and node voltages into column vectors, the KVL can be written in the concise form

$$\mathbf{v} = \mathbf{A}^T \cdot \mathbf{e} \quad (1.11)$$

Kirchhoff's current law can be generalized. Let a part of the circuit enclosed in a closed surface, sometimes called a *Gaussian surface* (Fig.1.8). Within the surface lie  $N$  nodes. Since the KCL holds for all these, the sum of all currents leaving them is  $\sum i = 0$ . Some of these currents flow to nodes which are outside the surface. The branches carrying these connect the circuit inside the surface to the rest of the circuit, and cutting these branches open will cause the circuit to be cut into parts. They are related to the *cutsets* of graph theory. In Fig. 1.8(a), a surface enclosing  $C_2$  and  $R_3$  shows that the currents through these elements are equal. Fig. 1.8(a) shows a test for parallel-connected two-ports. The Gaussian surface proves that in the test circuit both stages function as two-ports before the short is added between their outputs. In Fig. 1.8(b), a surface enclosing  $C_2$  and  $R_3$  shows that the currents through these elements are equal, and hence the charge in the enclosed space remains unchanged.

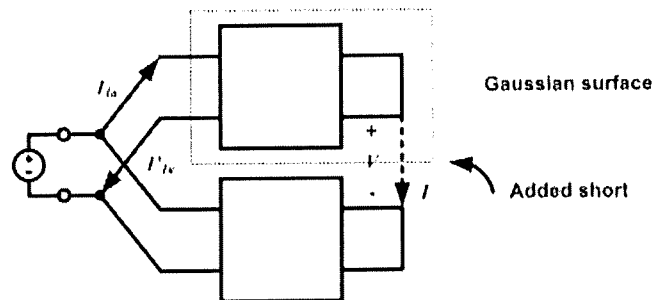

(a)

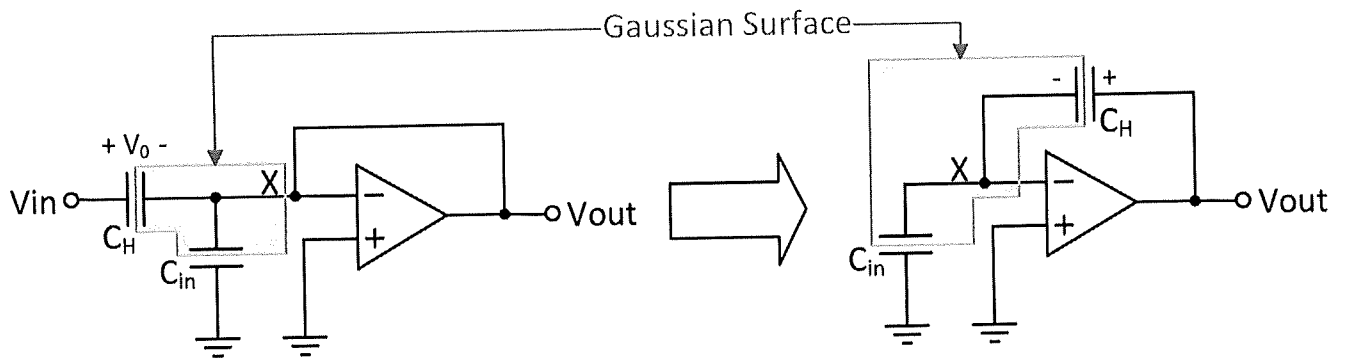

(b)

Figure 1.8: Circuits with Gaussian surfaces.

To prove that the total of the currents leaving a Gaussian circuit is zero, note that when we add up the currents leaving the nodes within the surface, those between internal nodes cancel since they leave one internal node but enter another. Thus, the total equals the sum of currents leaving the surface, which therefore also equals zero.

In conclusion, *the sum of currents leaving the part of a circuit within a closed surface is zero.* This is a useful generalization of the KCL. It can be applied in the analysis of both active and passive circuits. Note that the ground and bias nodes are not allowed to be within the surface.

Kirchhoff's laws are based solely on the configuration (topology) of the circuit. Adding the relationships between branch voltages and branch currents, the circuit can be fully analyzed. Operating in the Laplace transform domain, let  $Y_{ii}$  denote the sum of all admittances connected to node  $i$ , and let  $Y_{ij}$  denote the sum of all admittances connected between nodes  $i$  and  $j$ . We can construct the *nodal admittance matrix*  $Y$  from these admittance parameters such that  $y_{ij}$  is the element in row  $i$  and column  $j$ . Then the relation

$$Ye = I \quad (1.12)$$

describes all KCLs for every node. Here,  $I$  is the column vector of the source currents entering the nodes.

Solving (1.12) for the node voltages  $e_i$ , and finding the branch relations from the KVL, the network can be fully analyzed. This *nodal analysis* is the basis of most computer-based circuit analysis programs.

The process is simplified if there are grounded voltage sources in the circuit, since the voltages at their floating nodes are then known. Ungrounded voltage sources, however, require a somewhat more involved process, called *modified nodal analysis (MNA)*. In MNA, in addition to the node voltages in  $e$ , the unknowns include the currents flowing through the floating voltage sources. Consider a circuit with  $n$  nodes and  $s$  floating voltage sources. Then we can write  $n$  KCLs for the

nodes, and  $s$  KVLs for the voltage sources. Thus, for a voltage source  $v_{sl}$  connected between nodes  $a$  and  $b$ , a KVL of the form  $v_a - v_b = v_{sl}$  is added to the set of equations. The  $n + s$  equations can then be solved for the  $n$  node voltages and  $s$  currents through the voltage sources. Combined with the branch relations, this allows the complete analysis of the circuit.

Fig.1.9 shows an example of a circuit containing only resistors and current sources, which can be analyzed using nodal analysis.

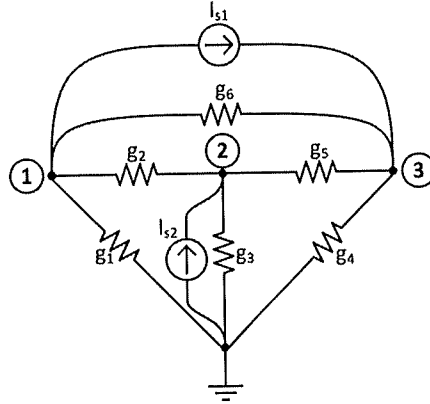

Figure 1.9. Circuit containing conductances and current sources.

The nodal equations are shown below. They are of the form  $\mathbf{G}\mathbf{v} = \mathbf{I}_s$ , where  $\mathbf{G}$  is the conductance matrix,  $\mathbf{v}$  is the vector of node voltages, and  $\mathbf{I}_s$  is the source vector.

$$\begin{bmatrix} g_2 + g_1 + g_6 & -g_2 & -g_6 \\ -g_2 & g_5 + g_2 + g_3 & -g_5 \\ -g_6 & -g_5 & g_6 + g_5 + g_4 \end{bmatrix} \begin{bmatrix} v_1 \\ v_2 \\ v_3 \end{bmatrix} = \begin{bmatrix} -I_{s1} \\ I_{s2} \\ I_{s1} \end{bmatrix} \quad (1.13)$$

$$\underline{\mathbf{G}} \underline{\mathbf{v}} = \underline{\mathbf{I}}_s$$

Figure 1.10 shows a similar circuit containing two floating voltage sources. Hence, direct nodal analysis cannot be used. Using the modified nodal analysis, the augmented nodal equations (1.14) result, which need to be solved for the node voltages and the currents  $i_{s1}$  and  $i_{s3}$  flowing through the voltage sources.

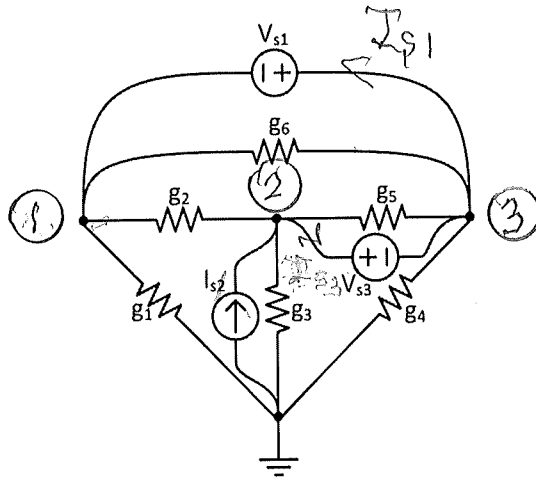

Figure 1.10. Circuit with two floating voltage sources.

5x5 MNA

$$\mathbf{G} \begin{bmatrix} -1 & 0 \\ 0 & 1 \\ 1 & -1 \end{bmatrix} \begin{bmatrix} v_1 \\ v_2 \\ v_3 \end{bmatrix} = \begin{bmatrix} 0 \\ I_s \\ 0 \end{bmatrix}$$
 (1.14)

$$\begin{bmatrix} -1 & 0 & 1 \\ 0 & 1 & -1 \\ 0 & 0 & 0 \end{bmatrix} \begin{bmatrix} i_{s1} \\ i_{s2} \\ i_{s3} \end{bmatrix} = \begin{bmatrix} v_{s4} \\ v_{s1} \end{bmatrix}$$

Sometimes, a floating voltage source has an impedance in series. Then, it can be transformed into a floating current source using Norton's equivalent circuit (**Fig. 1.11**). This allows using simple node analysis of the circuit.

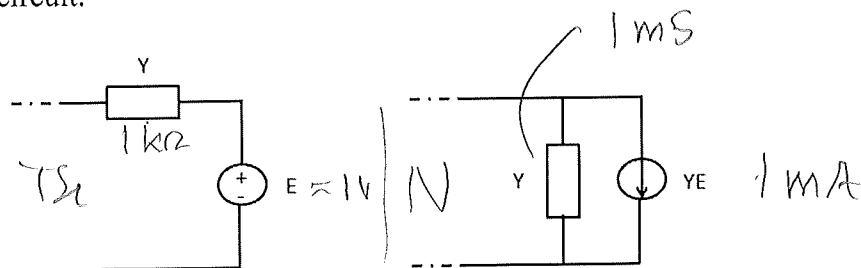
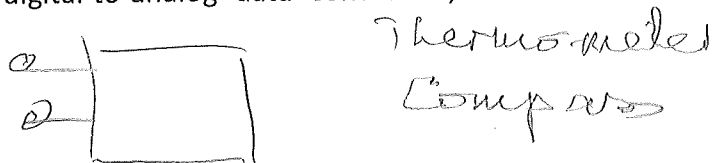
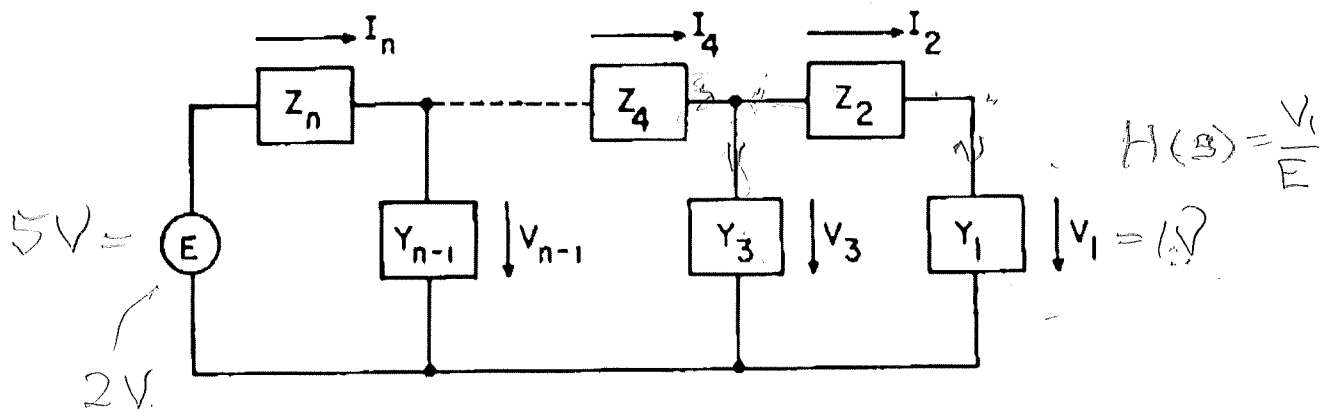

Figure 1.11: Norton's equivalence

*Example:* **Fig. 1.12** shows a ladder network, built from an alternation of series and shunt branches. Such circuits are used extensively in passive filters. They also play an important role in the design of analog-to-digital and digital-to-analog data converters, as well as in the modeling of



interconnects on an integrated circuit or printed circuit board. We assume that the circuit is linear and time-invariant.



Redraw with currents shown in wires and voltages with +/-.

Figure 1.12: Ladder network.

By applying KVL and KCL alternatively starting with the input branch and working forwards, the equations

$$\begin{aligned}
 E &= I_n Z_n + V_{n-1} & (1.15) \\
 0 &= -I_n + V_{n-1} Y + I_{n-1} \\
 &\dots \\
 0 &= -I_2 + V_1 I_1
 \end{aligned}$$

result. This is a set of  $n$  linear equations in the  $n$  unknowns  $V_1, I_2, V_3, I_4, \dots, V_{n-1}, I_n$ . The coefficient matrix has a special *tridiagonal* form, which allows a simple iterative algorithm for finding all unknowns [T.R. Bashkow, IRE Trans on Circuit Theory, June 1961]. From these, the remaining variables can be found from the branch relations. The solution process has a simple physical interpretation. Assume that the *output* voltage  $V_1$  is known, and is equal to 1 volt, and that we need to find the *input* voltage  $E_1$  for this output voltage. Then, starting with the output branch, and working *backwards*, we can find all unknowns one at a time. Thus,  $I_2 = Y_1 V_1$ . Next, we find  $V_3 = I_2 Z_2 + 1$ . Then,  $I_4 = V_3 Y_3 + I_2$ , etc. ..., until  $V_{n-1}$  and finally  $I_n$  are found. Then, the “unknown” input source is given by  $E_1 = Z_n I_n$ . At this point, we know the transfer function  $V_1/E_1$ . Since the circuit is linear, all actual voltages and currents can be obtained by multiplying the calculated values by  $E/E_1$ .

An important example of a ladder network is the *R-2R ladder*, shown in Fig. 1.13. Analysis using Bashkow’s method gives  $V_1 = 1$ ,  $V_3 = 2$ ,  $V_5 = 4$ , ... Thus, the node voltages and the currents flowing in the  $2R$  resistors are both binary weighted. This property of the circuit makes it a useful stage in digital-to-analog converters (DACs) [Carusone book]. Note that an even simpler way to analyze the *R-2R ladder* is to realize that the resistance seen to the *right* of each floating node is  $2R$ , while that seen to the *left* of the node is  $R$ . Thus, the circuit acts as a cascade of voltage and current dividers, scaling all quantities by powers of 2.

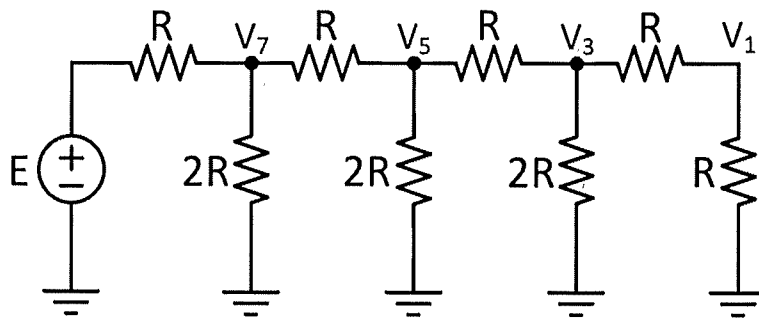

Figure 1.13: The R-2R ladder.

D/A    A/D

# Reciprocity and Inter-Reciprocity

Gabor Temes and Eric Wang

Fall 2021



Conservation

- The KCL (Kirchhoff's Current Law)
- States that the sum of the currents leaving each node is zero
- Define branch currents as  $I = [i_1, i_2, \dots, i_b]^T$



$$A_i = 0$$

Where  $b$  is the number of branches in the circuit,  $0$  is the column vector of zeros

*Define the incidence matrix  $A$*

$$a_{ij} = \begin{cases} +1 & \text{if branch } j \text{ leaves node } i \\ -1 & \text{if branch } j \text{ enters node } i \\ 0 & \text{if branch } j \text{ is not incident at node } i \end{cases}$$



- The KVL (Kirchhoff's Voltage Law):
  - States that the voltage across a branch is the difference of the node voltages at the terminals of the branch.
  - Denote  $v$  and  $e$  as the branch and node voltages, respectively. KVL gives  $v = A^T \cdot e$

*Notes*

# Tellegen's Theorem

- Consider the total power developed in all branches of the circuit shown below

$N \quad N' \quad (\hat{N})$

$$\sum_{k=1}^N v_k i_k = \mathbf{v}^T \cdot \mathbf{i} = (\mathbf{A}^T \mathbf{e})^T \mathbf{i} = \mathbf{e}^T (\mathbf{A} \mathbf{i}) = 0$$

$v^T i \approx 0$

- Conservation of the power
  - In any network, the summation of power is zero.
- Applications
  - Impedance synthesis, sensitivity analysis and noise computation

# Using Tellegen's Theorem in N-ports

- Consider two N-ports  $\mathbf{N}$  and  $\mathbf{N}'$  with the same  $\mathbf{A}$  matrices.

The previous equations give

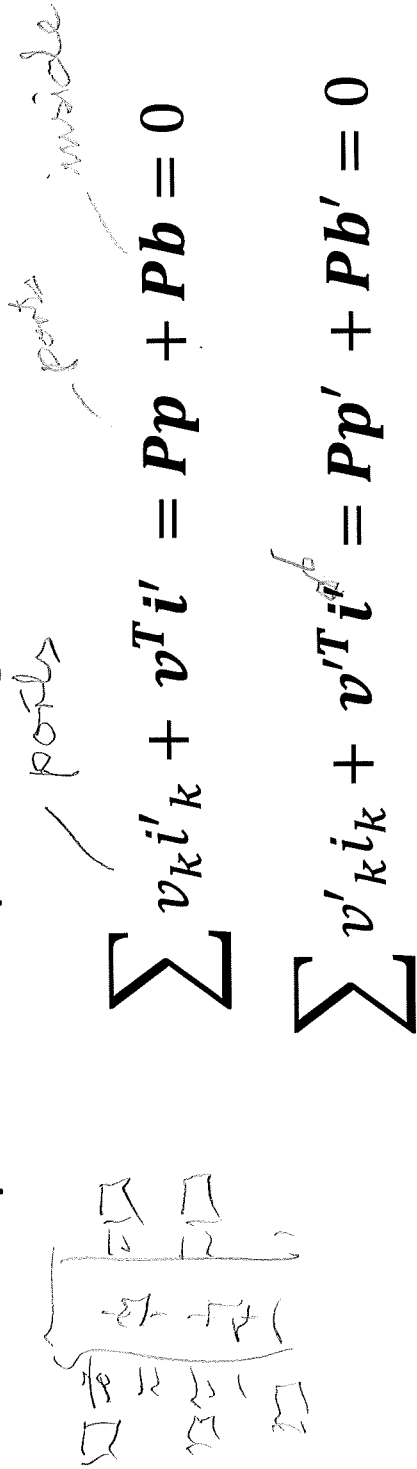

ports      ports      inside

$$\sum v_k i'_k + \mathbf{v}^T \mathbf{i}' = \mathbf{Pp} + \mathbf{Pb} = 0$$

$$\sum v'_k i_k + \mathbf{v}'^T \mathbf{i} = \mathbf{Pp}' + \mathbf{Pb}' = 0$$

Here,  $\mathbf{Pp}$  refers to the quantities in the branches at the port and  $\mathbf{Pb}$  refers to those inside the N-port in  $\mathbf{N}$ . The primed quantities  $\mathbf{Pp}'$  and  $\mathbf{Pb}'$  refer to the equivalent ones in  $\mathbf{N}'$ .

$$\mathbf{v}'^T \mathbf{v} = \mathbf{v}'^T \mathbf{v} \quad \mathbf{v} = \mathbf{R} \mathbf{i}$$

$$\mathbf{v}' = \mathbf{R}' \mathbf{i}'$$

# Using Tellegen's Theorem in N-ports

- If the inside structures of  $N$  and  $N'$  are such that  $Pb = Pb'$ , then  $Pp = Pp'$  also holds. The port voltages and currents satisfy this condition, or

$$\sum i_k v'_k = \sum i'_k v_k$$

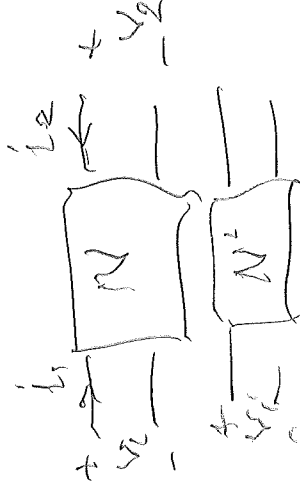

where  $i_k$  and  $v_k$  are the port currents and voltages under one set of excitations, while  $i'_k$  and  $v'_k$  are those under a different one, for the same N-port. Then, relations can be found between the transfer functions of the N-port!

**Such an N-port circuit is called reciprocal.**

# Two-Port Example-1

- Assume the following two circuits
  - contain only linear resistors, no controlled sources
  - have same internal branches, but different terminations
- Tellegen's Theorem gives

$$-v_2 \cdot i_2' + \sum_k v_k \cdot i_k' = -v_2 \cdot i_2' + \sum_k i_k' \cdot R_k \cdot i_k' = 0$$

$$v_1' \cdot i_1 + \sum_k i_k' \cdot R_k \cdot i_k' = 0$$

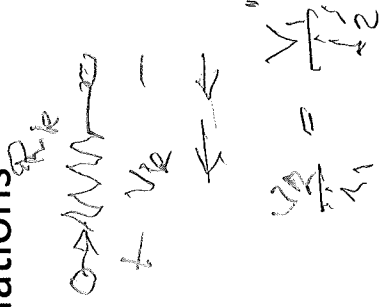

Subtracting the two gives  $-v_2 \cdot i_2' = v_1' \cdot i_1 \Rightarrow$  **Reciprocal**

Example:  $i_2 = i_1 = 0$

Circuit N

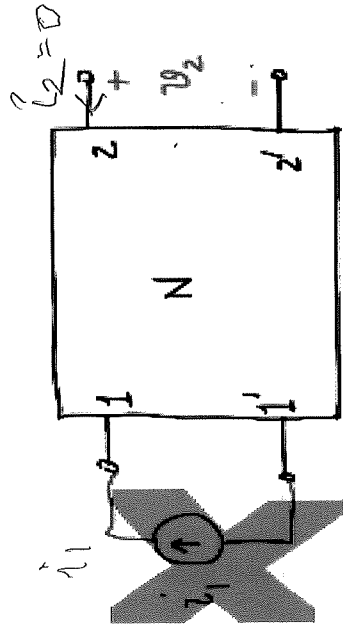

Circuit N'

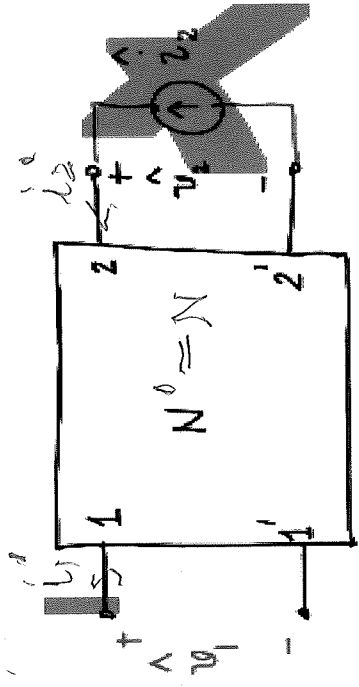

## Two-Port Example-2

- Thus, a two-port containing only resistors is reciprocal.
- Next, the port relations of  $N$  and  $N'$  are found for another two-port

$$\left\{ \begin{array}{l} \sum i_k v'_k = \sum i'_k v_k \Rightarrow \begin{cases} i_1 v'_1 = i'_2 v_2 \\ v_2 / i_1 = v'_1 / i'_2 \end{cases} \\ i_2 = i'_1 = 0 \end{array} \right.$$

**Note that  $v_2 / v_1 \neq v'_2 / v'_1$ !**

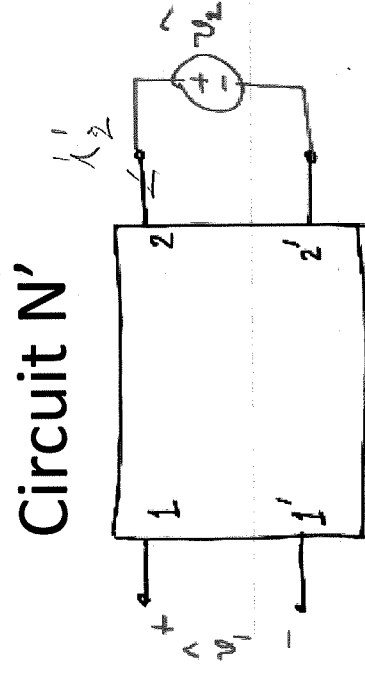
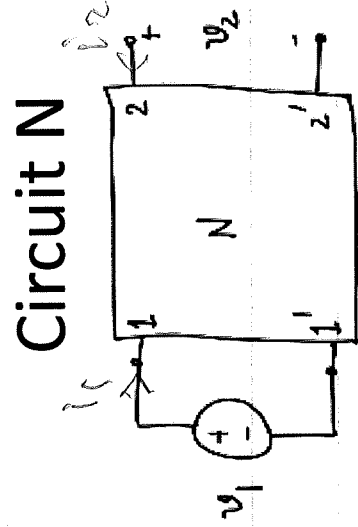

## Two-Port Example-2

- The forward transfer of  $N$  equals the reverse transfer function of  $N'$  only if the source impedances at the ports are the same
- Thus, a voltage source in  $N$  should be replaced by a short circuit in  $N'$ , and a current source replaced by an open circuit:

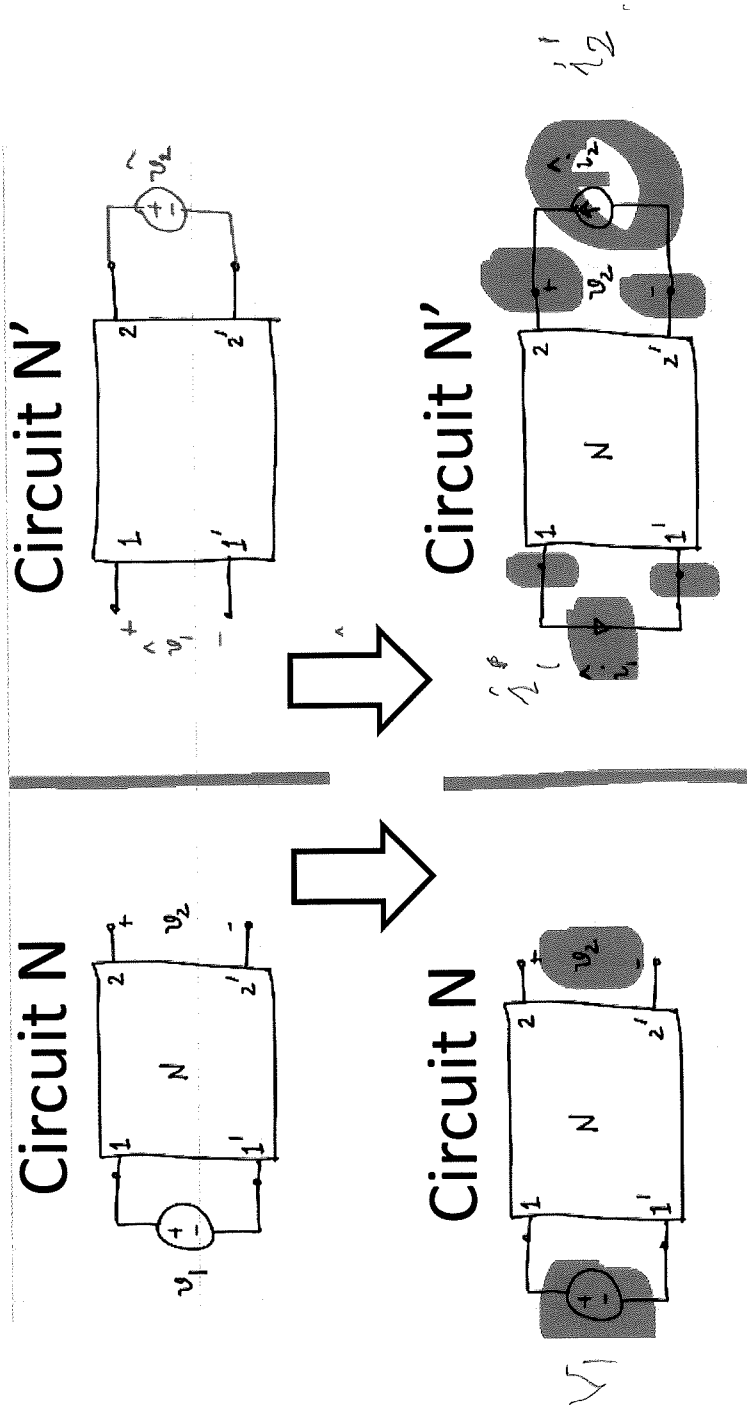



# Equal-impedance Termination

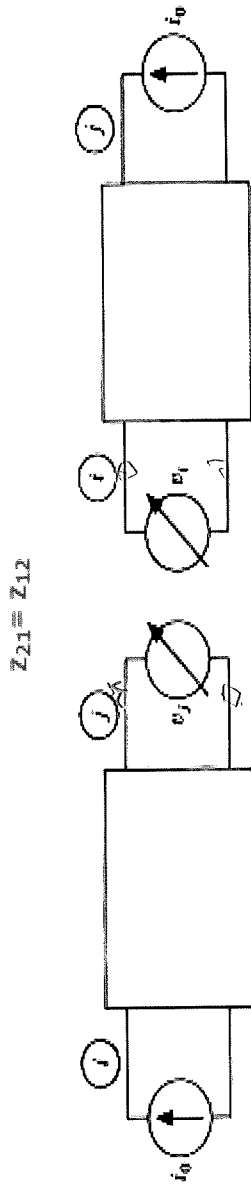

$v_i = v_j$

(a)

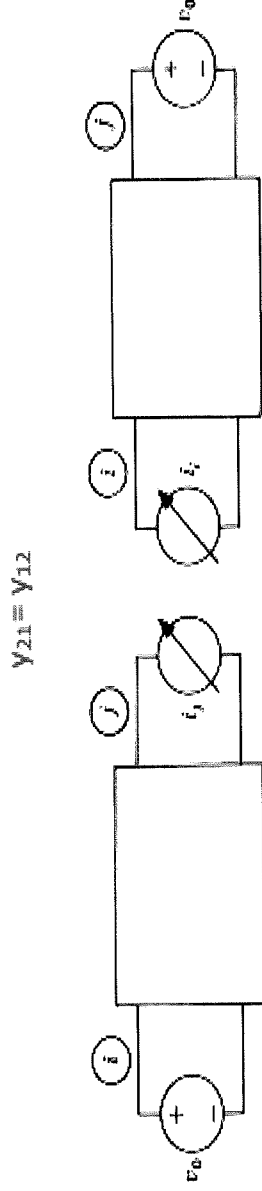

$i_j = i_i$

(b)

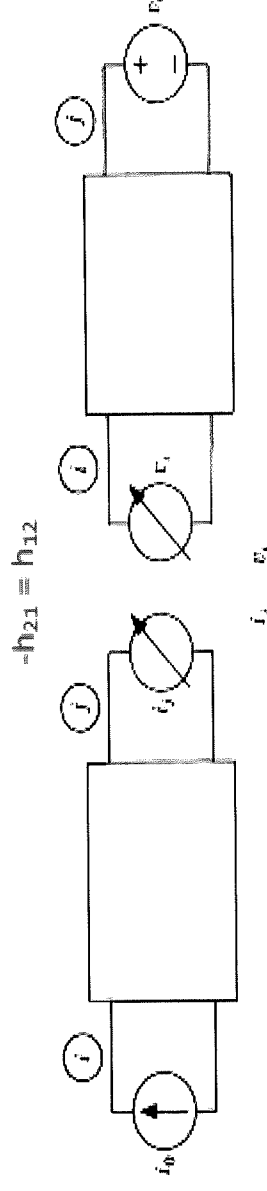

$i_i = v_i$

- Gains are equal. Valid also if two-ports are turned around.

# Reciprocity In Dynamic N-Ports



- Steady-state sine wave analysis represents voltages and currents by complex phasors  $V(j\omega)$ ,  $I(j\omega)$  in a linear circuit, and represents passive elements by their impedances  $Z_k(j\omega)$ .
- KCL, KVL and all previous derivations hold for the phasors, *also Laplace transforms!*
- Useful in the analysis of passive dynamic networks with multiple excitations, e.g., DACs (Digital-to-Analog Converters) design

# Examples Using Reciprocity

- Below shows a circuit containing five independent sources
- Analyze using superposition
- Requires five analysis, each with one nonzero source

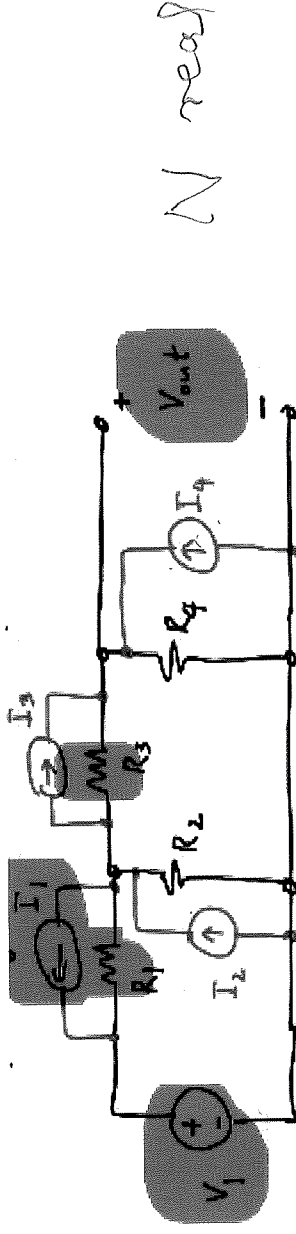

- Analyze using reciprocity
- Requires only one circuit analysis

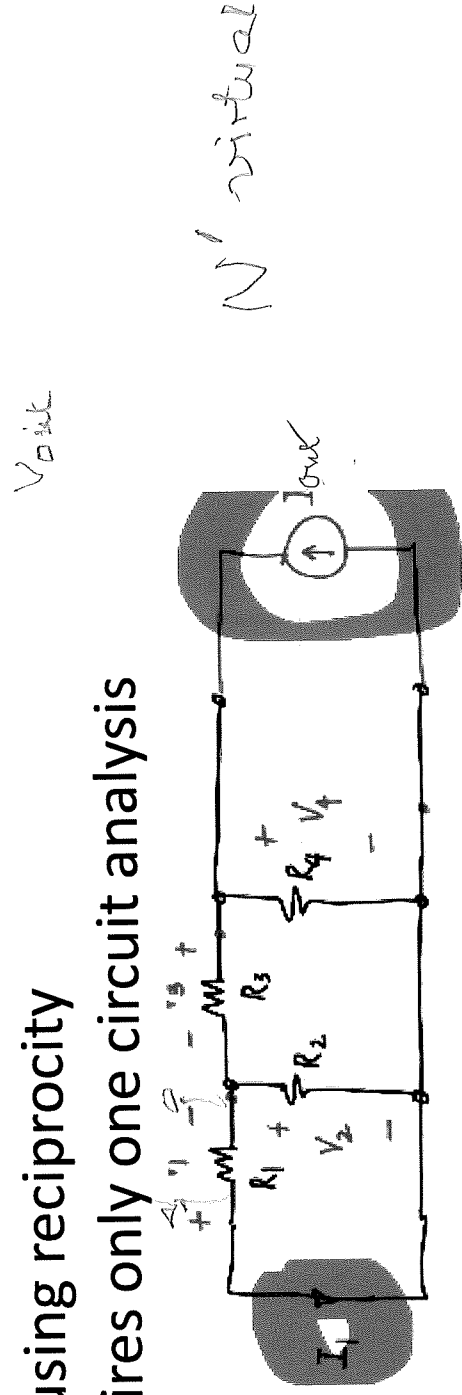

# Analyzing Circuits Using Reciprocity

- The contribution of the voltage source  $V_1$  to the output  $v_{out}$ 

$$v_{out}/V_1 = \overset{V_{in}}{i_1}/I_{out}$$
- and those of the current sources  $I_k$  are
 
$$v_{out}/I_k = v_k/I_k, k = 1, 2, \dots, 5$$
- The overall output voltage is the sum of these terms.

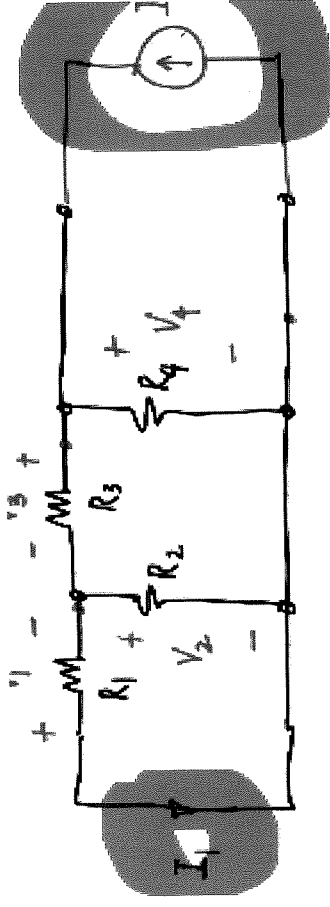
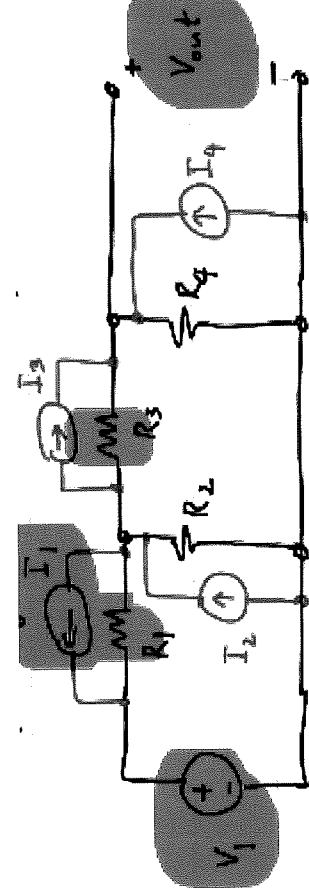

# Using Reciprocity in Analysis

- Using  $\sum i_k v_k' = \sum i_k' v_k$ , you find that the output voltage  $v_o$  is the weighted sum of the input source values. The weight of  $e_i$  is  $-j_i'$ , and that  $i_k$  is  $v_k$ . Also,  $Z_o$  is the same, so the Thevenin equivalent is readily found. No MNA needed!

$$P_b = P_b'$$

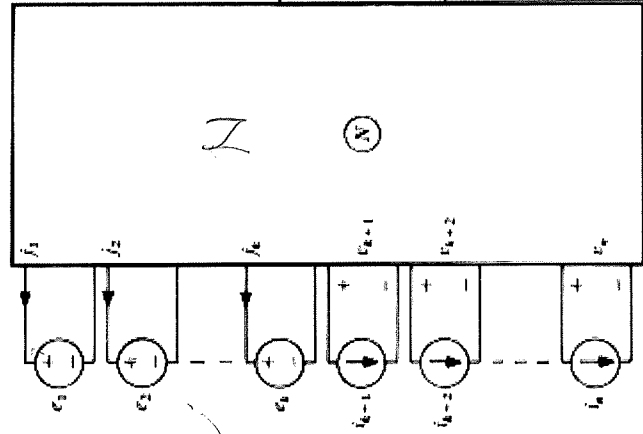
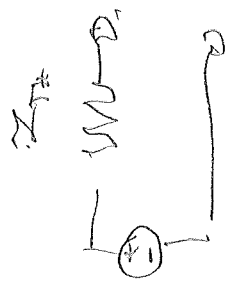

(a)

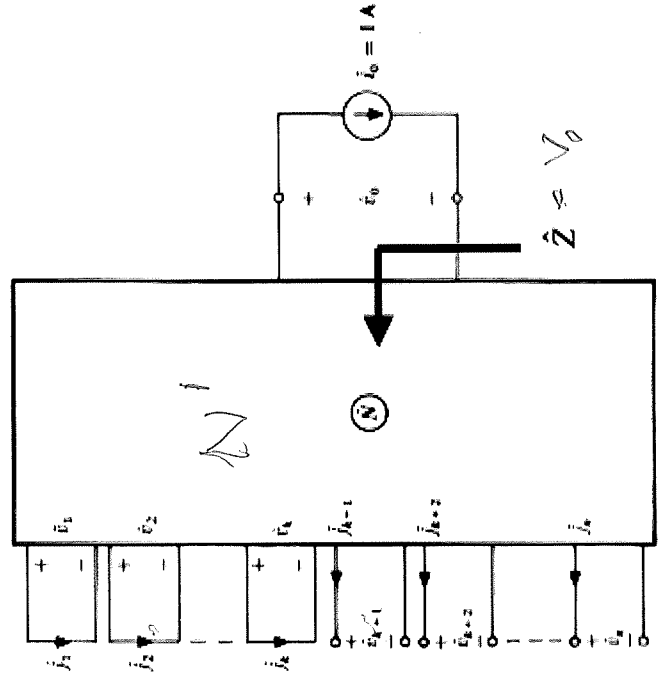

(b)

- **To analyze a reciprocal circuit containing several independent sources:**
  - 1) Redraw the circuit, setting the values of all independent sources to zero. Thus, voltage sources become short circuits, current sources open circuits in  $N'$ . → } A
  - 2) Replace the output signal with an independent source. Replace voltage with a current source  $I$  ; replace current with a voltage source  $V$  (e.g.,  $I = -1A$ , or  $V = 1V$ )
  - 3) Analyze the transformed network. The desired result will be the weighted sum of the independent source values in the physical circuit, with the weight factor of each current source the voltage across its zero valued replica, and that of each voltage source the current flowing across its short-circuit replica.

# Resistive N-Ports

- Assume an N-port circuit containing only resistors. To achieve  $\mathbf{Pb} = \mathbf{Pb}'$  for reciprocity,  $\mathbf{N}'$  must satisfy

$$\mathbf{v}_B^T \cdot \mathbf{G}' \cdot \mathbf{v}_B' = (\mathbf{v}_B')^T \cdot \mathbf{G} \cdot \mathbf{v}_B$$

*impedance  $Z = 1/R$*

where  $\mathbf{G}$  is the branch admittance matrix connecting the internal branch voltages and currents in  $\mathbf{N}$  by  $\mathbf{i}_B = \mathbf{G} \cdot \mathbf{v}_B$ , and similarly  $\mathbf{i}_B' = \mathbf{G}' \cdot \mathbf{v}_B'$ .

- Since the quantities on both sides are scalars, it is permissible to take the transpose of the right side. This gives

$$\mathbf{v}_B^T \cdot \mathbf{G}' \cdot \mathbf{v}_B' = \mathbf{v}_B^T \cdot \mathbf{G}'^T \cdot \mathbf{v}_B' \Rightarrow \mathbf{G}' = \mathbf{G}'^T \quad \mathbf{N}' = \mathbf{N}$$

- Hence, to achieve  $\mathbf{Pb} = \mathbf{Pb}'$ , the branch admittance matrix  $\mathbf{G}'$  of  $\mathbf{N}'$  must be the transpose of  $\mathbf{G}$ . If the circuit contains only resistors,  $\mathbf{G}$  is symmetric, so  $\mathbf{G}'^T = \mathbf{G}$ , and reciprocity is assured.



# Inter-Reciprocity and its Applications

---

- If the circuit contains controlled sources,  $\mathbf{N}'$  cannot be the same as  $\mathbf{N}$ . The reciprocity conditions fail for using the same N-port as  $\mathbf{N}'$ , since the  $\mathbf{G}$  matrix will not be symmetric.  $\mathbf{N}'$  must be chosen so as to restore  $\mathbf{G}' = \mathbf{G}^T$ . *Adjoint network*
- An adjoint network is a modified version  $\mathbf{N}'$  of the physical network  $\mathbf{N}$ , which is constructed such that the reciprocity condition on the port currents and voltages

$$i_1 v_1' + i_2 v_2' = i_1' v_1 + i_2' v_2$$

is restored for the two networks. By Tellegen's theorem, this requires the condition  $\sum i_k v_k' = \sum i_k' v_k$  to be valid separately for both port and interior branches. The relation between  $\mathbf{N}$  and  $\mathbf{N}'$  is called *inter-reciprocity*.

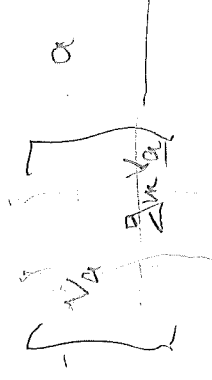



# Inter-Reciprocity in R-VCCS N-Port

- To satisfy  $\mathbf{Pb} = \mathbf{Pb}'$ , we must have for branches  $a$  &  $b$

$$i_a v'_a + i_b v'_b = i'_a v_a + i'_b v_b$$

which can be used to find the two branches in  $N'$  corresponding to the VCVS

- For the VCCS, the branch relations are

$$i_a = 0 \text{ and } i_b = g_m v_a$$

- The above two equations give the reciprocity condition which is

$$i'_a - g_m v'_b = -i'_b (v_b / v_a)$$



# Inter-Reciprocity

- The equation derived must hold true for all values of  $v_b/v_a$

$$i'_a - g_m v'_b = -i'_b (v_b/v_a) \Rightarrow$$

- Only possible when

$$a \leftrightarrow b$$

$$i'_b = 0 \text{ and } i'_a = g_m v'_b \quad i_a = 0 \quad i_b = g_m v_a$$

- The image in  $\mathbf{N}'$  of the VCCS of circuit  $\mathbf{N}$  is thus another VCCS but turned around!  $\mathbf{G}' = \mathbf{G}^T$

- If there are several VCCS's in  $\mathbf{N}$ , then the adjoint network  $\mathbf{N}'$  must contain such appropriately modified replicas (i.e., turned around VCCS stages) for all of them.

similar for CCVS, different for VCVS, CCCS,  
flip around

# Modified Generalized Method

---

- **To analyze multi-source active networks using inter-reciprocity:**
  - 1) Draw the adjoint circuit  $\mathbf{N}'$ , setting the values of all previous independent sources to zero. Thus, voltage sources become short circuits, current sources open circuits.
  - 2) Replace the original output signal with an independent source. If it is voltage, replace it with a current source  $I$ ; if it is a voltage source, with a voltage source  $V$  (e.g.,  $I = -1\text{A}$ , or  $V = 1\text{V}$ ).
  - 3) Analyze the *adjoint network*  $\mathbf{N}'$ . The desired result for the output in  $\mathbf{N}$  will be the weighted sum of the independent source values in  $\mathbf{N}$  with the weight of each current source the voltage across its zero valued replica, and that of each voltage source the current flowing across its short-circuit replica.

# Applications of Inter-Reciprocity

- Inter-reciprocity can also be used to efficiently obtain the Thevenin equivalent of a linear circuit with multiple independent and dependent sources.
- Obtain the output impedance  $Z$  of the network  $N$  by setting all independent sources to zero, and find the output voltage when the output port is excited by a  $-1\text{ A}$  current source.

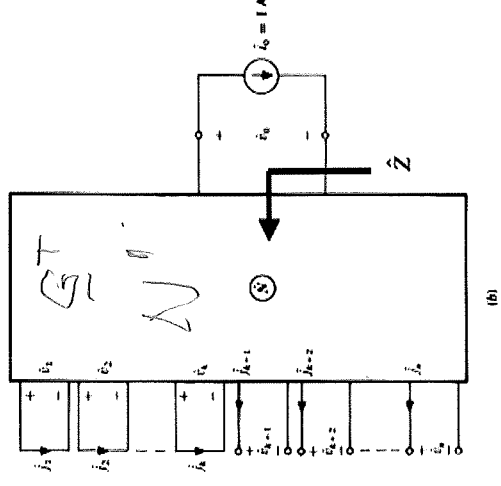
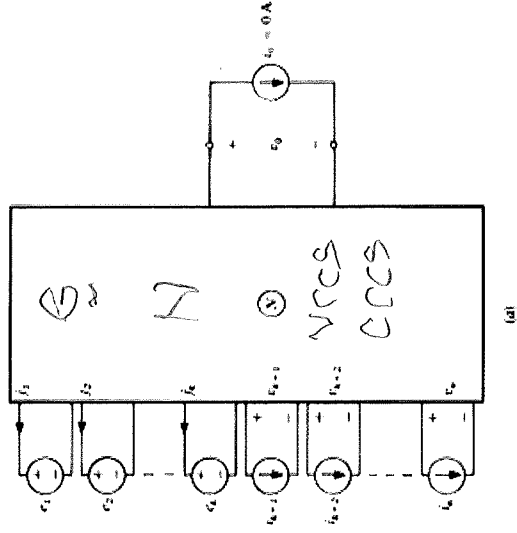

# Applications of Inter-Reciprocity

- By inter-reciprocity, we have
- Hence, the impedance in the Thevenin model numerically equals the output voltage of N'

$$v'_o i_o = i'_o v_o$$

$$Z = Z' = -v'_o$$

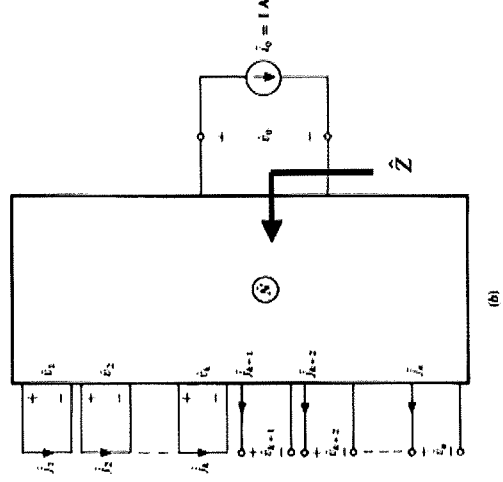
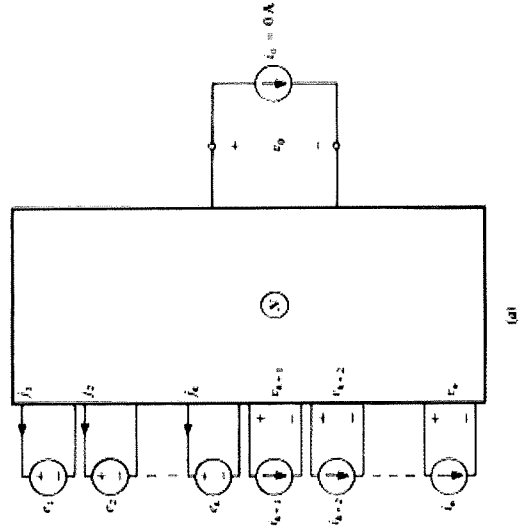

# Noise Analysis Using Inter-Reciprocity



- Every transistor in CMOS IC is affected by thermal noise (random motion of the channel charge carriers) and by flicker noise or 1/f noise (trapping and releasing of charge carriers).
- This noise effect can be modeled by a single independent noise voltage source at the gate of the device.
- Inter-reciprocity can be applied to find the output noise.

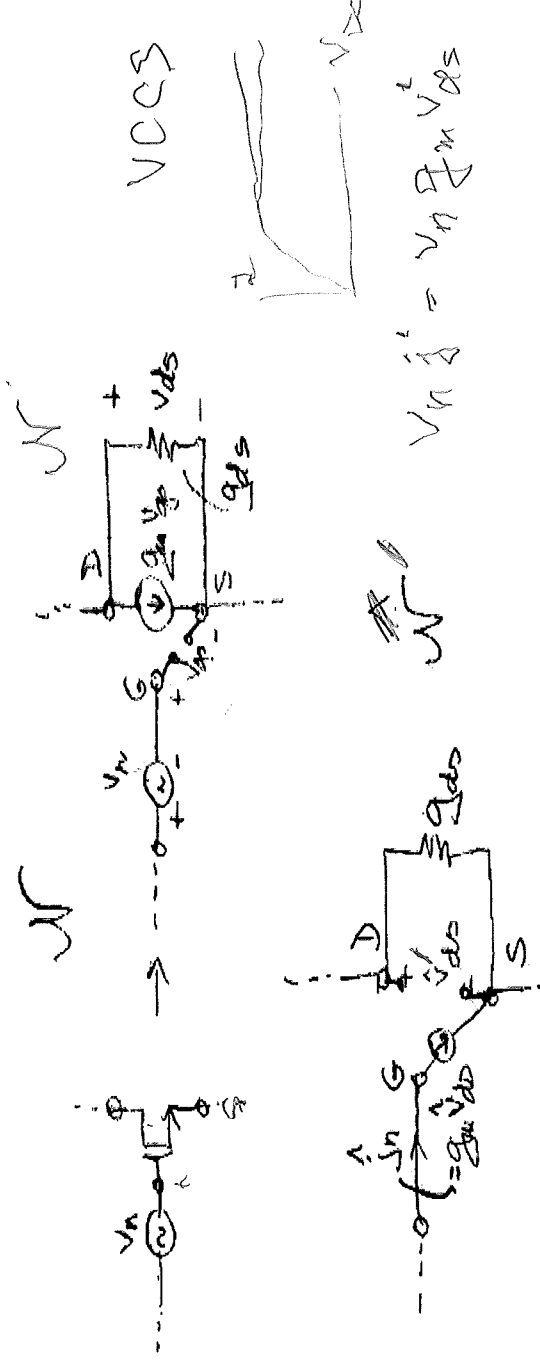

# Noise Analysis Using Inter-Reciprocity

- Model each transistor with a transconductance  $g_m$  and drain-to-source conductance  $g_{ds}$ .
- In the adjoint network, the transconductance is turned around.
- Using inter-reciprocity, the contribution of the noise voltage  $v_n$  to the output noise power will be  $(j'_n)^2 \stackrel{(v_n)}{=} (g_m v'_{ds})^2 v_n^2$ .

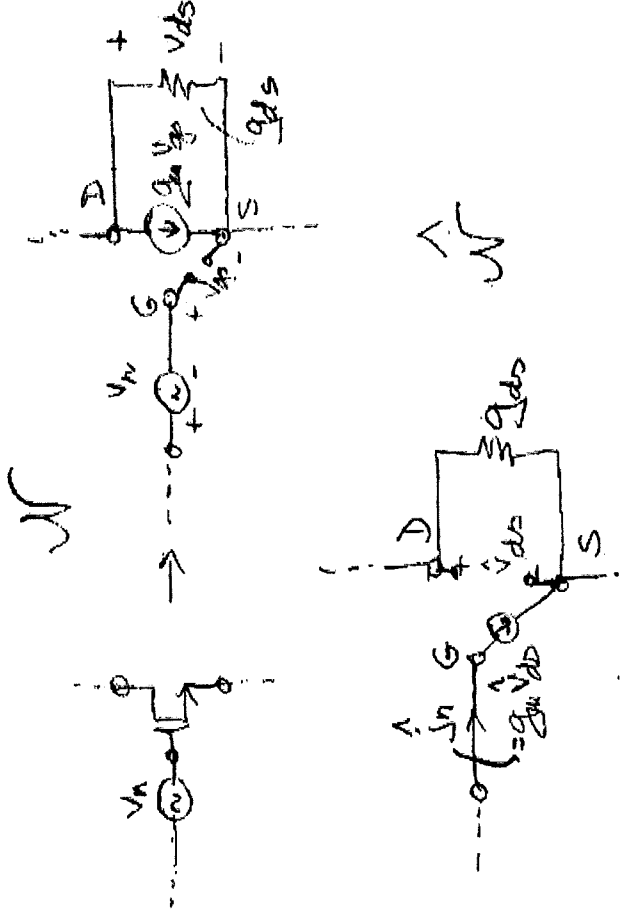

# OSU Sensitivity Analysis Using Inter-Reciprocity

---

- The values of the circuit components will deviate from their theoretical ones when implementing circuits.
- The adjoint network is an efficient way to calculate the sensitivities of the key performance parameters, as suggested by Director and Rohrer [4][5].
- Assume a two-port containing resistors and VCCs with all component values having a small error, changing  $G$  to  $G + \Delta G$ .
- Using the adjoint network  $N'$  with its transconductance matrix  $G' = G^T$ , we have for the internal branches the change  $\Delta P b = v_B^T \cdot \Delta G \cdot v_B$ . Based on this, the sensitivities of the output to conductances and transconductances can be found.

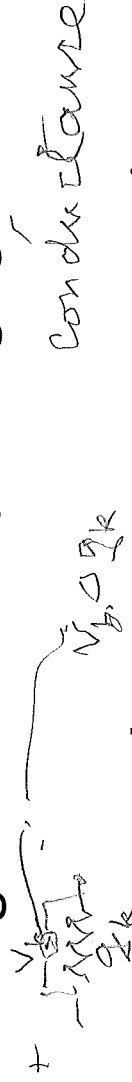

Added current sources  $\Delta G \cdot v_B$



# Process of Sensitivity Analysis

---

- Assume a voltage output  $v_{out}$  for the physical circuit  $N$  containing resistors and VCCSs. The process is as follows;
- 1) Construct the adjoint network  $N'$ , in which the values of all independent sources of  $N$  are set to zero. Resistive branches remain unchanged, controlled sources replaced by their adjoint models. At the output port, place a current source  $I = 1$  A.
  - 2) Calculate the branch voltages  $v'_k$  across all resistors. According to the discussions above, the contribution of the incremental change  $\Delta G_k$  of an admittance  $G_k$  to  $\Delta v_{out}$  will be  $v'_k \cdot v_k \cdot \Delta G_k$ . Thus, the output sensitivity to variations in  $G_k$  will be  $\Delta v_{out} / \Delta G_k = v'_k \cdot v_k$ .
  - 3) To find the sensitivity to changes in the transconductance  $G_{Im}$  of a VCCS between branches  $m$  and  $l$ , find the controlling voltages  $v_m$  and  $v'_l$  in  $N$  and  $N'$ . The sensitivity is  $\Delta v_{out} / \Delta G_{Im} = v'_l \cdot v_m$ .

---

# References

- [1] B.D.H. Tellegen, "A general network theorem, with applications," Philips Res. Rept., **7**, pp. 259-269, 1952.
- [2] Temes, G.C., "A physical proof of Tellegen's theorem," *Proc. of the IEEE*, 57(6):1183-1184, June 1969.
- [3] Bordewijk, J. L., "Inter-reciprocity applied to electric networks," *Appl. Sci. Res.*, Sec **B**, pp. 1-74, 1956.
- [4] Director, S. W. and Rohrer, R.A., "The generalized adjoint network and network sensitivities," *IEEE Trans. Circuit Theory*, Aug. 1969, pp. 318-323.
- [5] Director, S. W. and Rohrer, R.A., "Automated network design: the frequency domain case," *IEEE Trans. Circuit Theory*, Aug. 1969, pp. 330-337.

T - Lap book Ch. 9-10

